

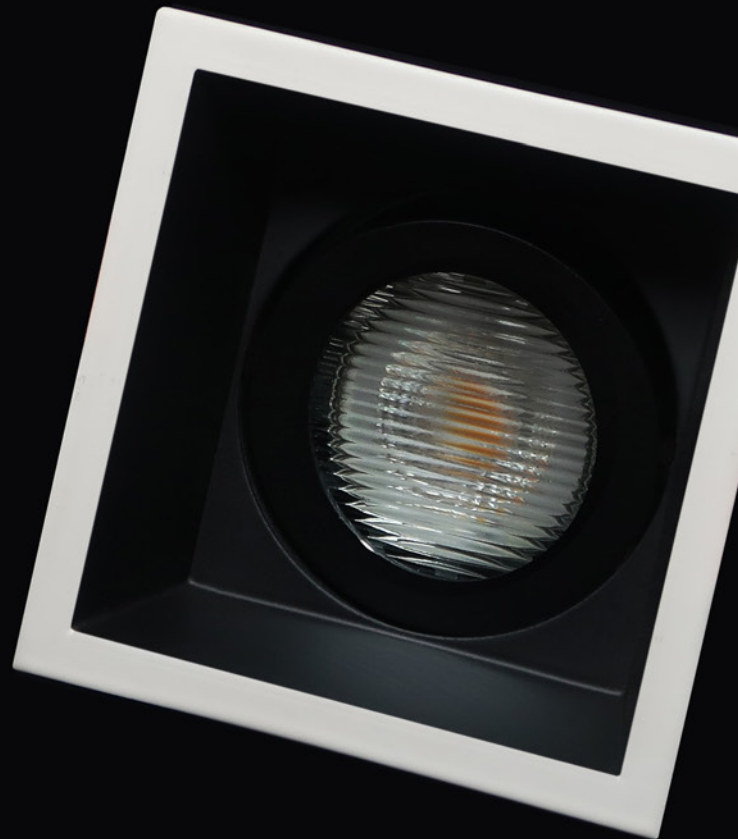

ARTEFACTOS PARA EMBUTIR PARA DICROICA
DE ALUMINIO INYECTADO. ORIENTABLES,
FIJOS Y CARDANICOS. VARIEDAD DE OPTICAS.



TEVET-R



G1

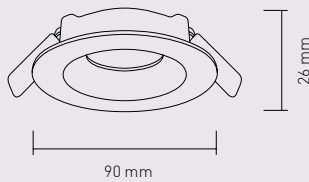

G1 10W

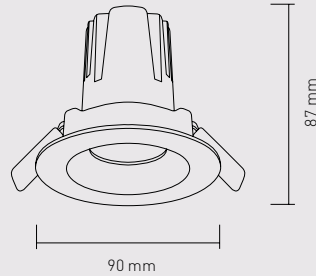

G1 15W

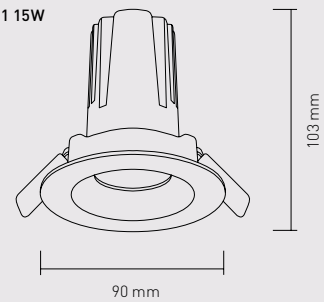

75 mm

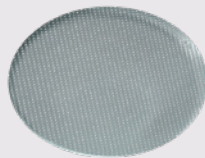

Filtro de vidrio templado (IP44)



Filtro asimétrico

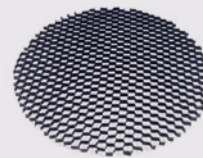

Panal de abeja antideslumbrante

Artefacto para embutir **fijo**.
Aluminio inyectado.
Opcional: tres filtros adaptables a cada necesidad.

TEVET-C



G2

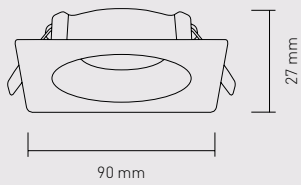

G2 10W

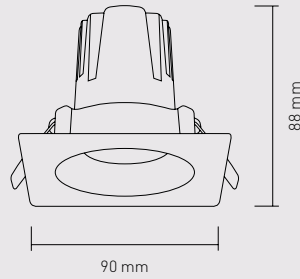

G2 15W

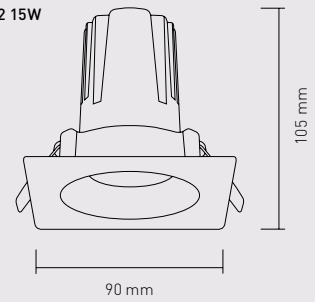

75 mm

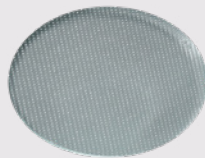

Filtro de vidrio templado (IP44)

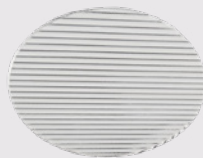

Filtro asimétrico

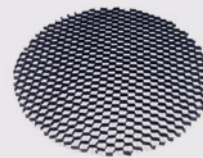

Panel de abeja antideslumbrante

Artefacto para embutir **fijo**.
Aluminio inyectado.
Opcional: tres filtros adaptables a cada necesidad.



KELEV-R



G14

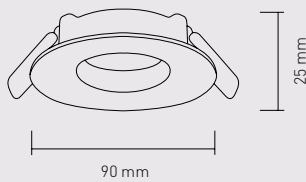

G14 10W

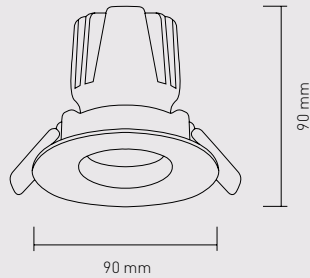

G14 15W

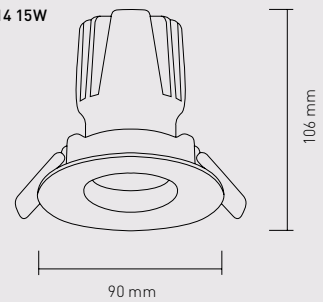

75 mm

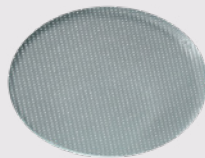

Filtro de vidrio templado (IP44)

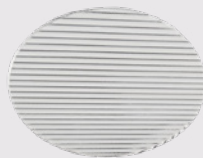

Filtro asimétrico

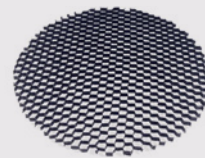

Panal de abeja antiodislumbrante

Artefacto para embutir **fijo**.
Aluminio inyectado.
Opcional: tres filtros adaptables a cada necesidad.

KELEV-C



G15

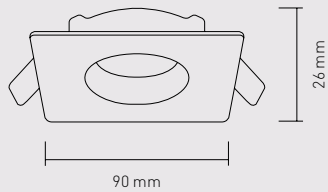

G15 10W

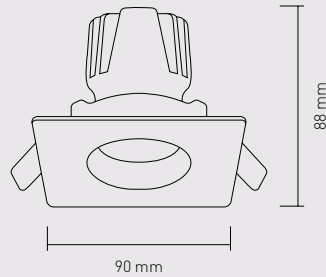

G15 15W

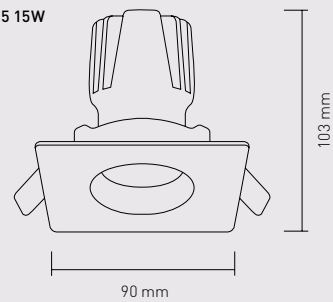

 75 mm

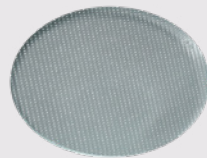

Filtro de vidrio templado (IP44)

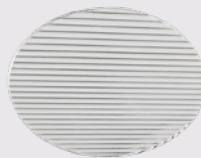

Filtro asimétrico

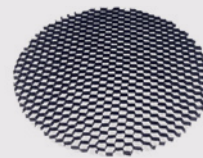

Panal de abeja antideslumbrante

Artefacto para embutir **fijo**.
Aluminio inyectado.
Opcional: tres filtros adaptables a cada necesidad.



ELUL-C



G12

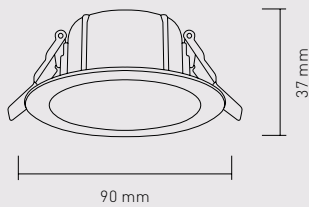

G12 10W

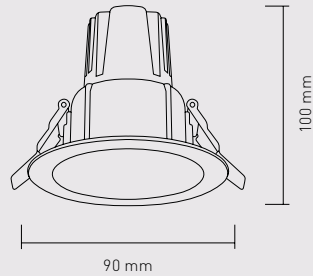

G12 15W

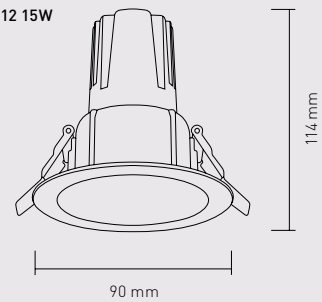

70 mm

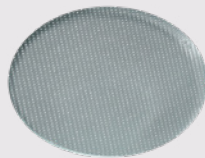

Filtro de vidrio templado (IP44)

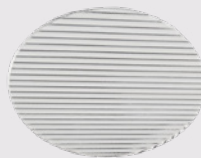

Filtro asimétrico

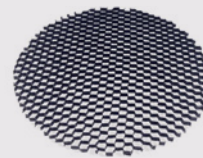

Panal de abeja antidislumbrante

Artefacto para embutir **fijo**.
Aluminio inyectado.
Opcional: tres filtros adaptables a cada necesidad.

ELUL-G



G13

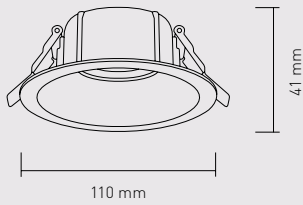

G13 10W

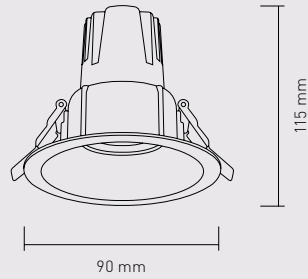

G13 15W

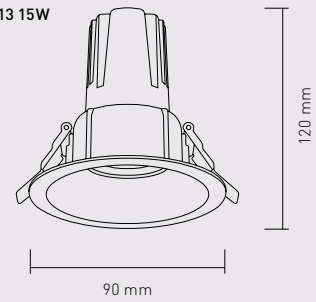

90 mm

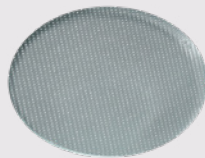

Filtro de vidrio templado (IP44)

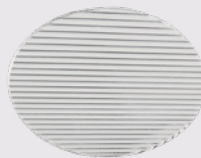

Filtro asimétrico

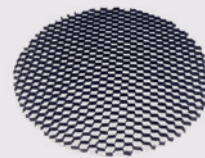

Panel de abeja antideslumbrante

Artefacto para embutir **fijo**.
Aluminio inyectado.
Opcional: tres filtros adaptables a cada necesidad.



SHEVAT-R



G3

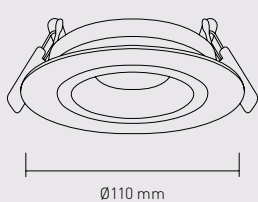

Ø110 mm

39 mm

G3 10W

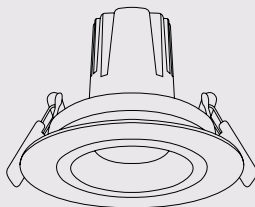

Ø110 mm

87 mm

G3 15W

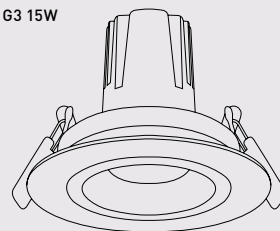

Ø110 mm

105 mm

⌀ 90 mm

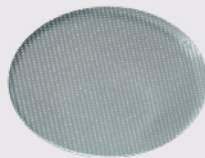

Filtro de vidrio templado (IP44)

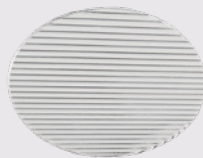

Filtro asimétrico

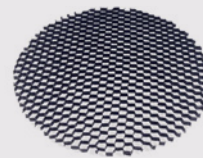

Panal de abeja antidislumbrante

Artefacto para embutir **cardánico**.
Aluminio inyectado.
Opcional: tres filtros adaptables a cada necesidad.

Housing para hormigón

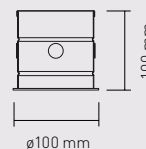

SHEVAT-RNN



G22

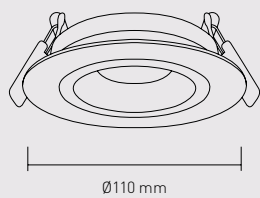

Ø110 mm

39 mm

G22 10W

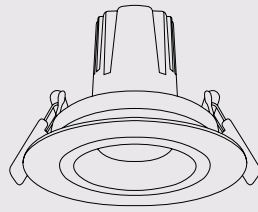

Ø110 mm

87 mm

G22 15W

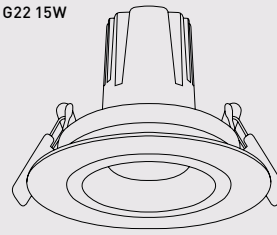

Ø110 mm

105 mm

Ⓛ 90 mm

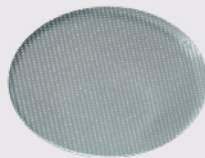

Filtro de vidrio templado (IP44)

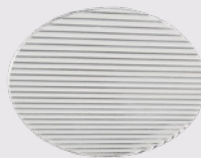

Filtro asimétrico

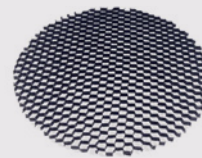

Panal de abeja antideslumbrante

Artefacto para embutir **cardánico**.
Aluminio inyectado.
Opcional: tres filtros adaptables a cada necesidad.

Housing para hormigón

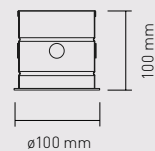

SHEVAT-CNN



G23

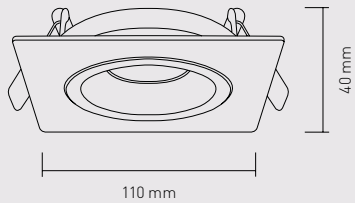

G23 10W

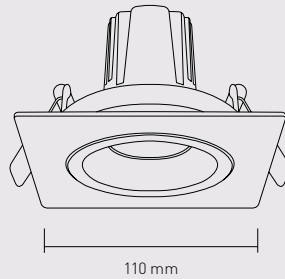

G23 15W

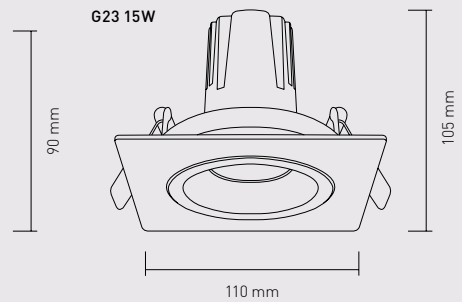

90 mm

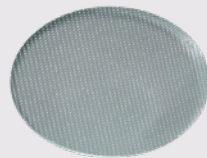

Filtro de vidrio templado (IP44)

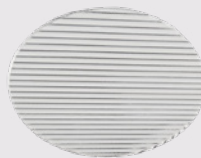

Filtro asimétrico

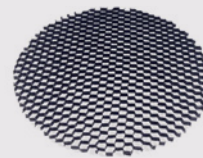

Panal de abeja antideslumbrante

Artefacto para embutir **cardánico**.
Aluminio inyectado.
Opcional: tres filtros adaptables a cada necesidad.

Housing para hormigón

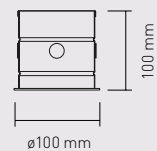

SHEVAT-C



G4

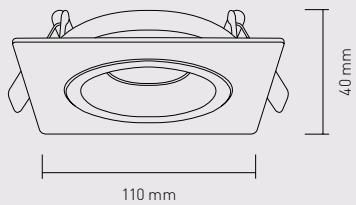

G4 10W

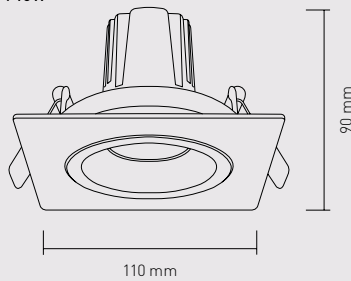

G4 15W

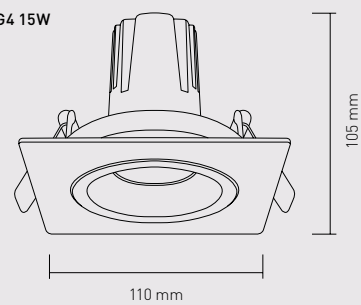

90 mm

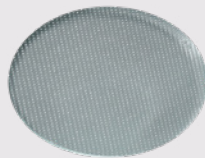

Filtro de vidrio templado (IP44)

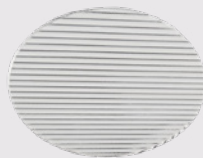

Filtro asimétrico

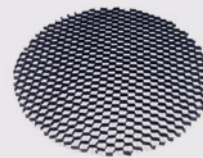

Panal de abeja antideslumbrante

Artefacto para embutir **cardánico**.
Aluminio inyectado.
Opcional: tres filtros adaptables a cada necesidad.

Housing para hormigón

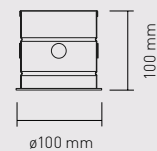

ADAR-B



G5

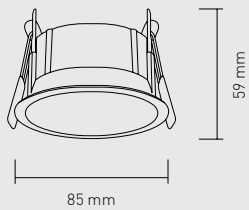

G5 10W

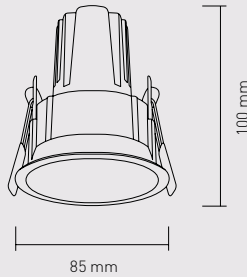

G5 15W

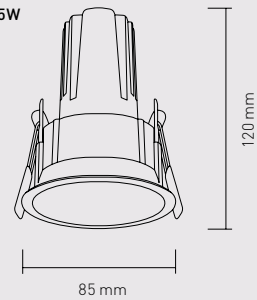

75 mm

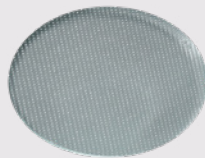

Filtro de vidrio templado (IP44)

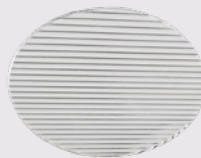

Filtro asimétrico

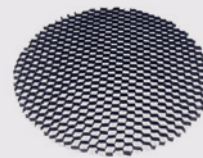

Panal de abeja antideslumbrante

Artefacto para embutir **orientable**.
Aluminio inyectado.
Opcional: tres filtros adaptables a cada necesidad.

Housing para hormigón

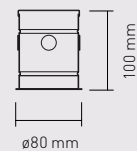

ADAR-N



G6

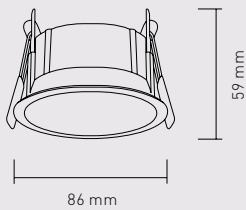

G6 10W

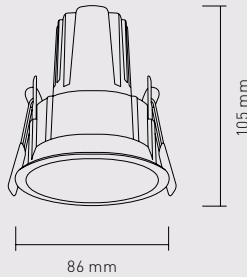

G6 15W

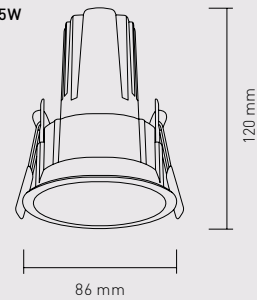

75 mm

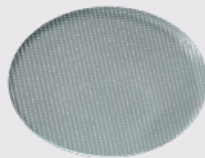

Filtro de vidrio templado (IP44)

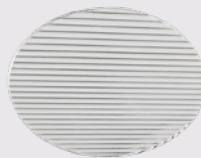

Filtro asimétrico

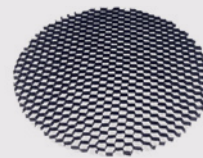

Panel de abeja antidislumbrante

Artefacto para embutir **orientable**.
Aluminio inyectado.
Opcional: tres filtros adaptables a cada necesidad.

Housing para hormigón

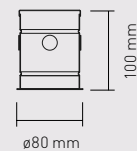

5 AÑOS DE GARANTÍA



ADAR-NN



G24

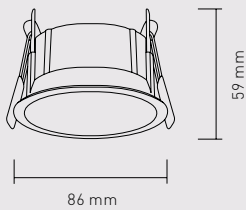

G24 10W

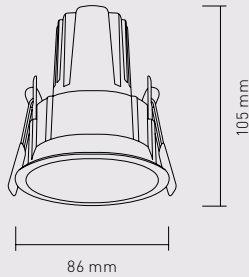

G24 15W

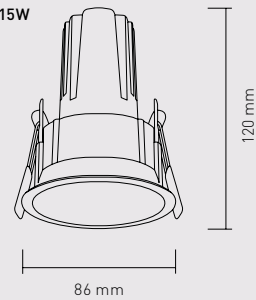

 75 mm

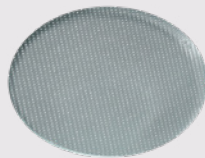

Filtro de vidrio templado (IP44)



Filtro asimétrico

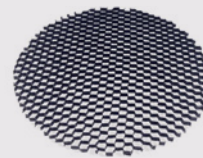

Panal de abeja antidislumbrante

Artefacto para embutir **orientable**.
Aluminio inyectado.
Opcional: tres filtros adaptables a cada necesidad.

Housing para hormigón

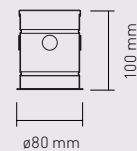

SIVAN-B

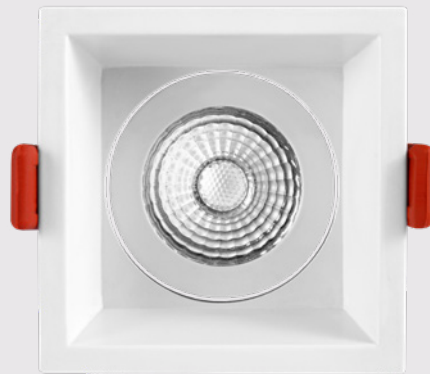

G7

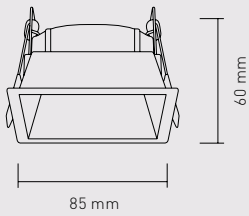

G7 10W

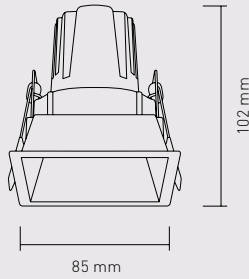

G7 15W

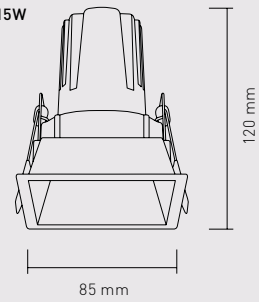

↕ 75 x 75 mm

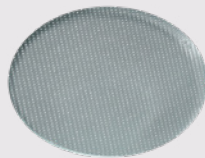

Filtro de vidrio templado (IP44)

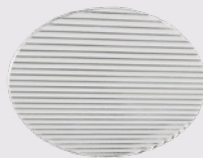

Filtro asimétrico

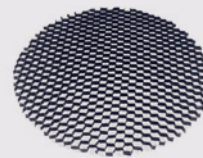

Panal de abeja antideslumbrante

Artefacto para embutir **orientable**.
Aluminio inyectado.
Opcional: tres filtros adaptables a cada necesidad.

Housing para hormigón

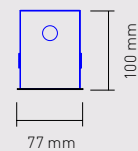

5 AÑOS DE GARANTÍA



SIVAN-N

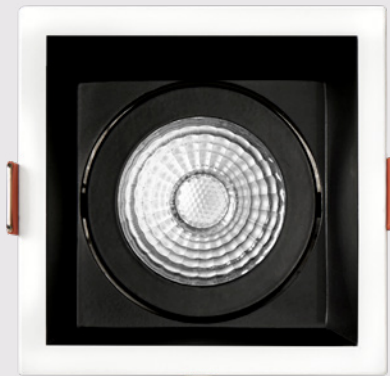

G8

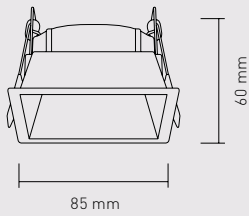

G8 10W

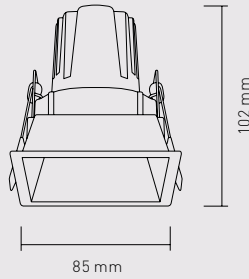

G8 15W

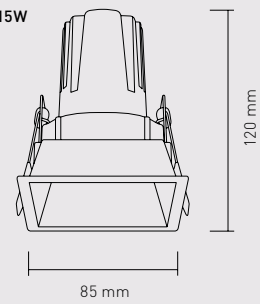

75 x 75 mm

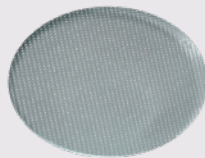

Filtro de vidrio templado (IP44)

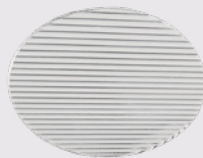

Filtro asimétrico

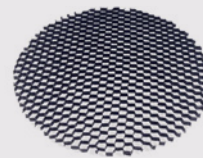

Panal de abeja antideslumbrante

Artefacto para embutir **orientable**.
Aluminio inyectado.
Opcional: tres filtros adaptables a cada necesidad.

Housing para hormigón

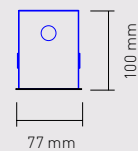

SIVAN-NN



G25

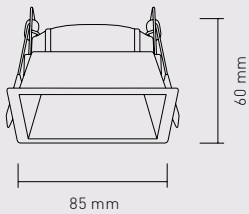

G25 10W

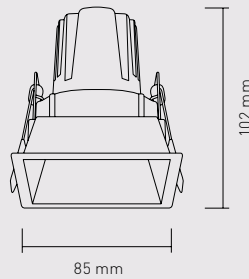

G25 15W

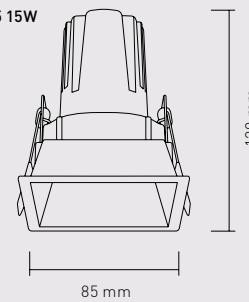

↕ 75 x 75 mm

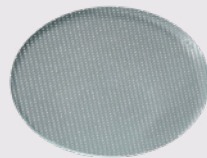

Filtro de vidrio templado (IP44)

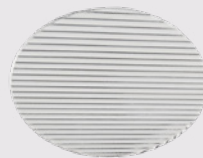

Filtro asimétrico

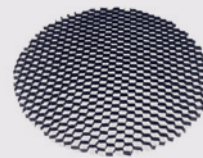

Panel de abeja antideslumbrante

Artefacto para embutir **orientable**.
Aluminio inyectado.
Opcional: tres filtros adaptables a cada necesidad.

Housing para hormigón

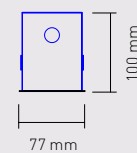

5 AÑOS DE GARANTÍA



WASHER-B



G9

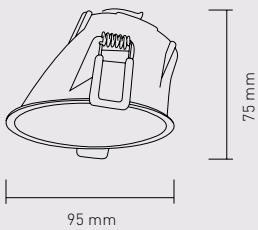

G9 10W

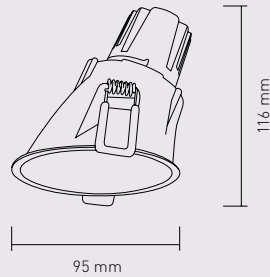

G9 15W

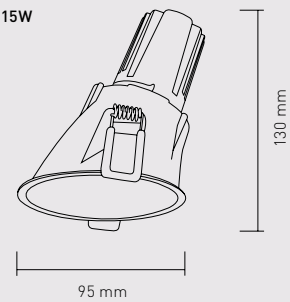

87 mm

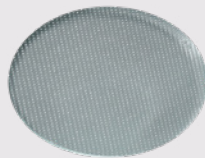

Filtro de vidrio templado (IP44)

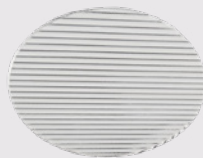

Filtro asimétrico

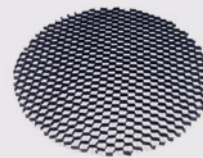

Panal de abeja antideslumbrante

Artefacto para embutir **fijo**.

Aluminio inyectado.

Opcional: tres filtros adaptables a cada necesidad.



JATUL-RF



G16

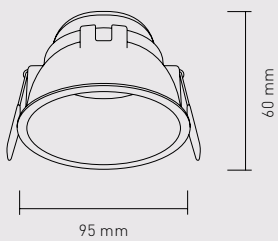

G16 10W

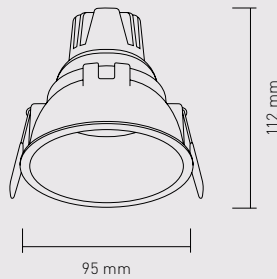

G16 15W

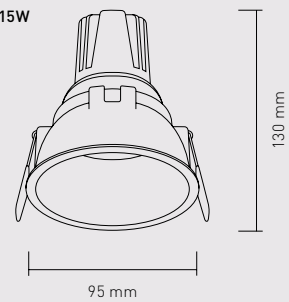

91 mm

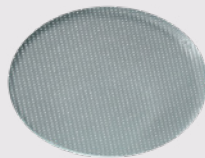

Filtro de vidrio templado (IP44)

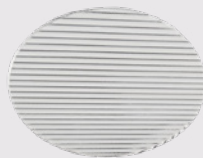

Filtro asimétrico

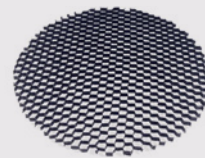

Panel de abeja antideslumbrante

Artefacto para embutir **fijo**.
Aluminio inyectado.
Opcional: tres filtros adaptables a cada necesidad.



JATUL-R0



G17

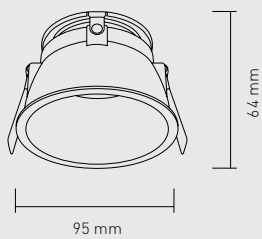

G17 10W

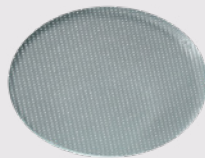
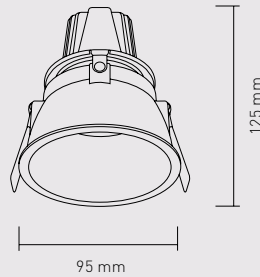

Filtro de vidrio templado

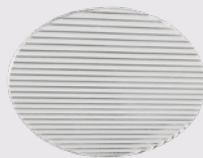

Filtro asimétrico

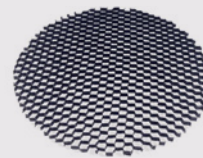

Panal de abeja antidislumbrante

Artefacto para embutir **orientable**.

Aluminio inyectado.

Opcional: tres filtros adaptables a cada necesidad.



5 AÑOS DE GARANTÍA



TAMUS-R

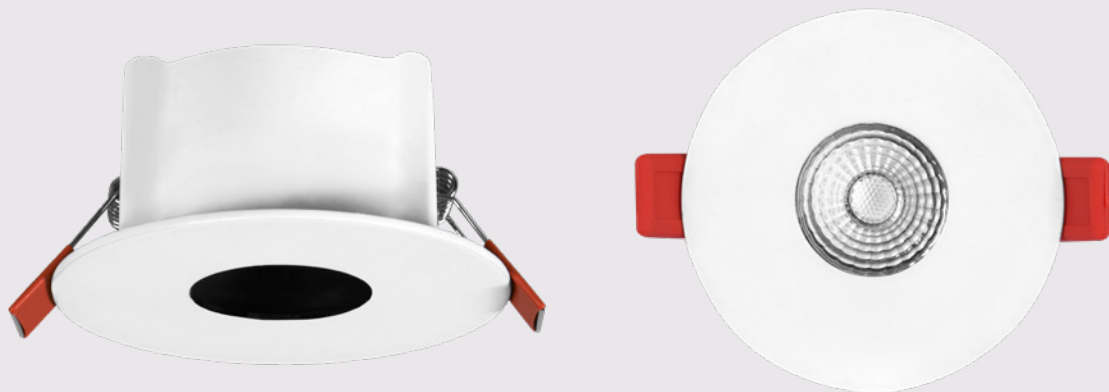

G10

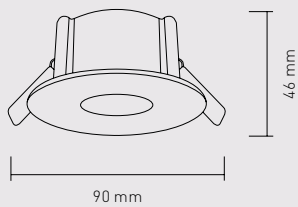

G10 10W

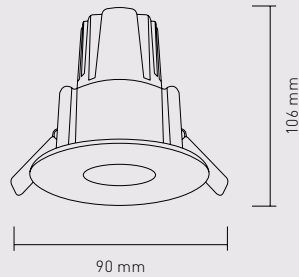

G10 15W

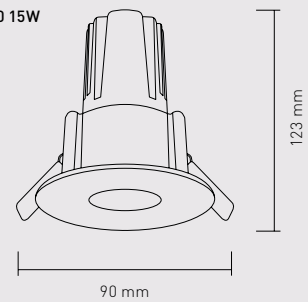

 75 mm

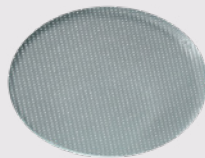

Filtro de vidrio templado (IP44)

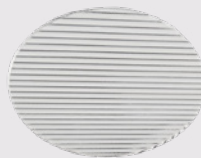

Filtro asimétrico

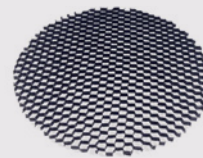

Panal de abeja antideslumbrante

Artefacto para embutir **fijo**.
Aluminio inyectado.
Opcional: tres filtros adaptables a cada necesidad.

Housing para hormigón

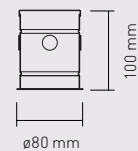

TAMUS-C



G18

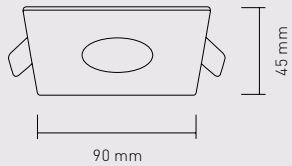

G18 10W

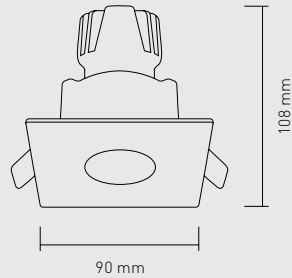

G18 15W

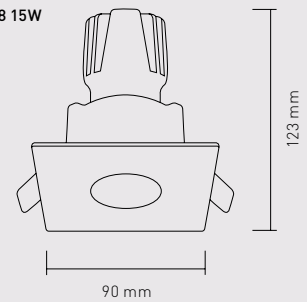

75 mm

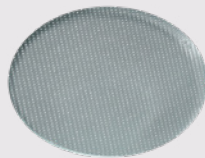

Filtro de vidrio templado (IP44)

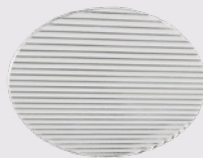

Filtro asimétrico

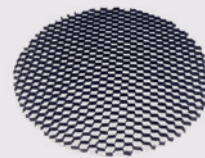

Panal de abeja antideslumbrante

Artefacto para embutir **fijo**.
Aluminio inyectado.
Opcional: tres filtros adaptables a cada necesidad.

TAMUS-0



G11

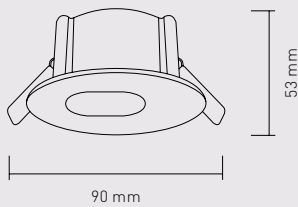

G11 10W

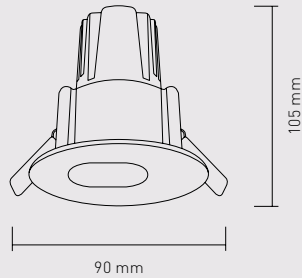

G11 15W

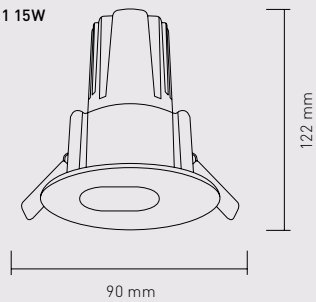

68 mm

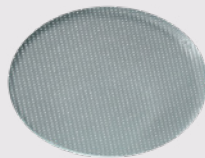

Filtro de vidrio templado (IP44)

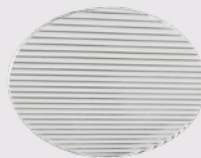

Filtro asimétrico

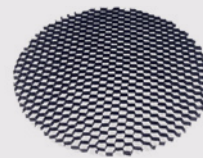

Panel de abeja antideslumbrante

Artefacto para embutir **orientable**.
Aluminio inyectado.
Opcional: tres filtros adaptables a cada necesidad.



TAMUS-M



G19

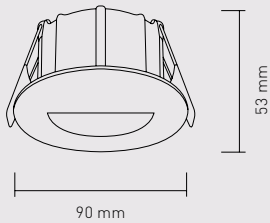

G19 10W

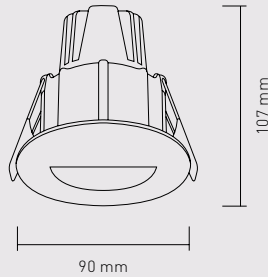

G19 15W

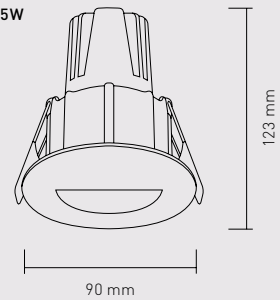

75 mm

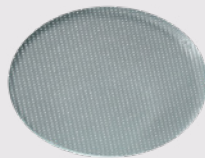

Filtro de vidrio templado (IP44)

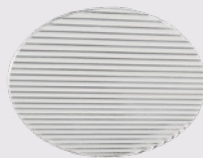

Filtro asimétrico

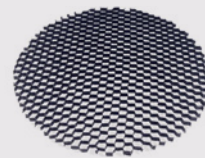

Panal de abeja antidislumbrante

Artefacto para embutir **orientable**.
Aluminio inyectado.
Opcional: tres filtros adaptables a cada necesidad.

JAZIR-R



G20

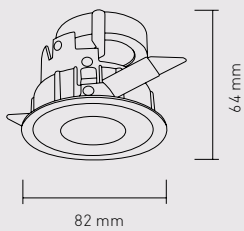

G20 10W

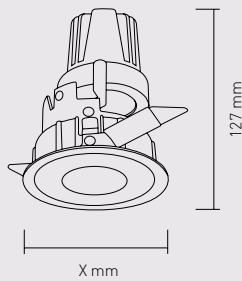

G20 15W

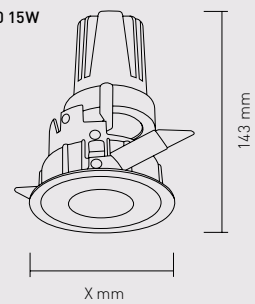

75 mm

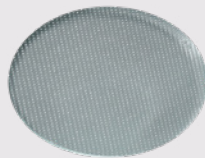

Filtro de vidrio templado (IP44)

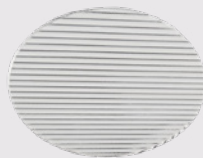

Filtro asimétrico

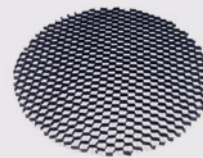

Panal de abeja antideslumbrante

Artefacto para embutir **orientable**.
Aluminio inyectado.
Opcional: tres filtros adaptables a cada necesidad.



JAZIR-C



G21

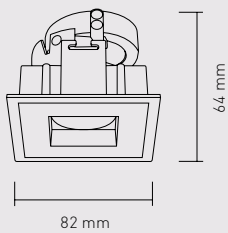

G21 10W

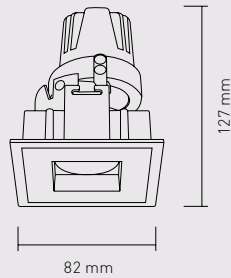

G21 15W

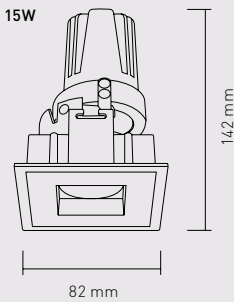

↕ 75 x 75 mm

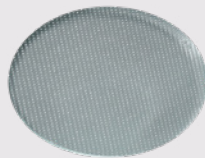

Filtro de vidrio templado (IP44)

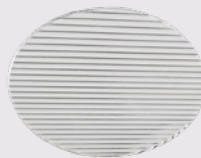

Filtro asimétrico

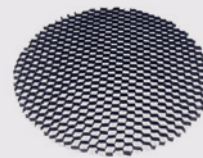

Panal de abeja antislumbrante

Artefacto para embutir **orientable**.
Aluminio inyectado.
Opcional: tres filtros adaptables a cada necesidad.