



AÑOS  
DE GARANTÍA

LM  
80



## CINOR 11W

Tracklight con driver dimerizable para embutir en riel.  
Cuerpo de aluminio. Antideslumbrante color negro incluido

 740 lm

 11W 220V

 CRI >90

 PF 0.9

 Dim

 20° / 27° / 36°

 2700K / 3000K / 4000K

 Acabado: negro/blanco

# CINOR 11W

## ESPECIFICACIONES TÉCNICAS

Código	CT	Dim.	Sist. dim	Áng.	CRI	lm	lm/W	W	V	IP
TL45	2700K	Sí	TRIAC	20°/27°/36°	>90	705	70	11	220	20
TL45	3000K	Sí	TRIAC	20°/27°/36°	>90	740	65	11	220	20
TL45	4000K	Sí	TRIAC	20°/27°/36°	>90	820	75	11	220	20

MacAdam <5

## DISTRIBUCIÓN DE INTESIDAD LUMÍNICA

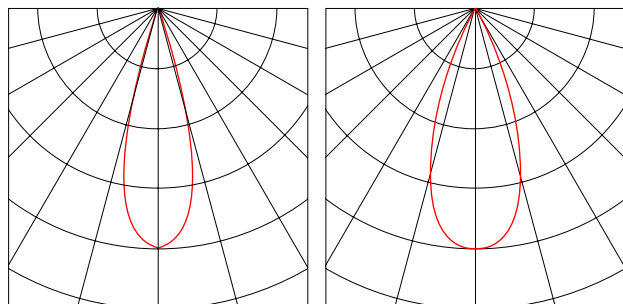

$I_{max}=4244$  cd  
 $\alpha$  C0-C180 =20°

$I_{max}=2900$  cd  
 $\alpha$  C0-C180 =27°

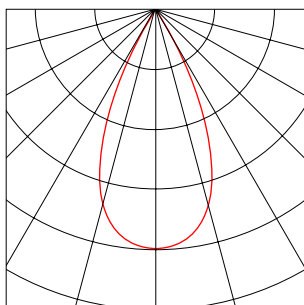

Parámetros  
de fotometría en 3000K

$I_{max}=1552$  cd  
 $\alpha$  C0-C180 =36°

## PROYECCIÓN DE LUZ A DISTANCIA

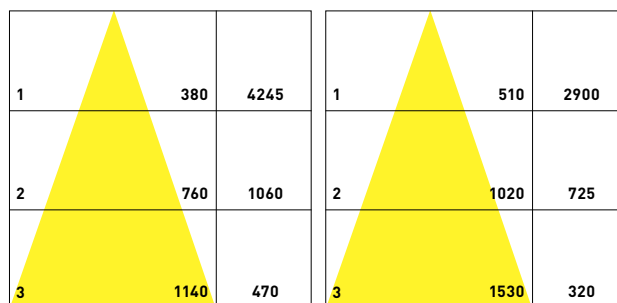

M (Altura) 20° mm (Diámetro) lx

M (Altura) 27° mm (Diámetro) lx

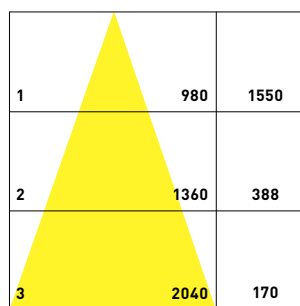

M (Altura) 36° mm (Diámetro) lx

## DIMENSIONES SPOT 11W

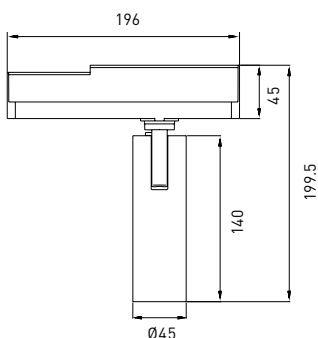

Driver y adaptador incluidos.  
Opción driver DALI disponible.



# CINOR 11W

## RIELES COMPATIBLES

---

Riel 3 efectos marca Artelum modelos: 53411, 53412 y 53413

Riel 3 efectos marca Starnova modelos "Euro"

## ACCESORIOS OPCIONALES

---

Código	Descripción
TL-20W-DPOT	Driver lineal para armado de Cinor en perfil de 20W. Válido para 2 Cinor 11W o 1 Cinor 20W.
TL-30W-DPOT	Driver lineal para armado de Cinor en perfil de 30W. Compatible únicamente con Cinor 27W.

## CONFIGURABLE

---

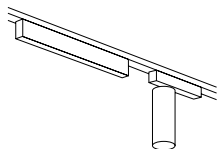

Los artefactos de la línea Cinor son configurables con perfiles Linear, Linear Slim y Slim Box.

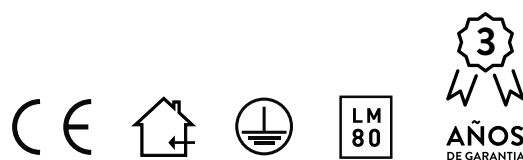



AÑOS  
DE GARANTÍA

LM  
80



# CINOR 20W

Tracklight con driver dimerizable para embutir en riel.  
Cuerpo de aluminio. Antideslumbrante color negro incluido

 1520 lm

 20W 220V

 CRI >90

 PF 0.9

 Dim

 20° / 27° / 36°

 2700K / 3000K / 4000K

 Acabado: negro/blanco

# CINOR 20W

## ESPECIFICACIONES TÉCNICAS

Código	CT	Dim.	Sist. dim	Áng.	CRI	lm	lm/W	W	V	IP
TL55	2700K	Sí	TRIAC	20°/27°/36°	>90	1445	70	20	220	20
TL55	3000K	Sí	TRIAC	20°/27°/36°	>90	1520	75	20	220	20
TL55	4000K	Sí	TRIAC	20°/27°/36°	>90	1595	80	20	220	20

MacAdam <5

## DISTRIBUCIÓN DE INTESIDAD LUMÍNICA

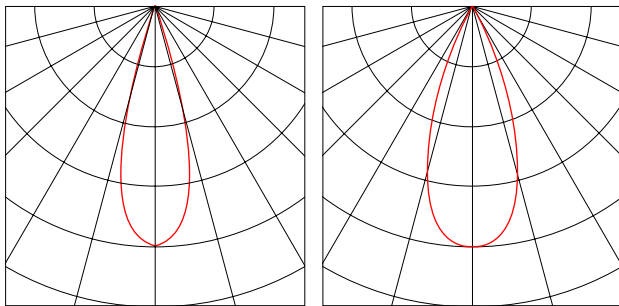

$I_{max}=9150$  cd  
 $\alpha$  C0-C180 =20°

$I_{max}=7425$  cd  
 $\alpha$  C0-C180 =27°

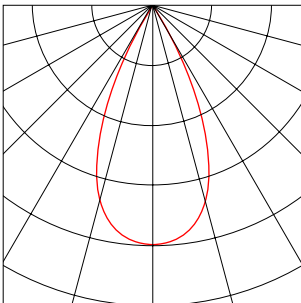

Parámetros de fotometría en 3000K

$I_{max}=4297$  cd  
 $\alpha$  C0-C180 =36°

## PROYECCIÓN DE LUZ A DISTANCIA

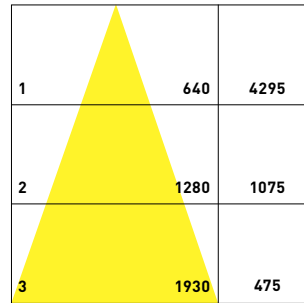
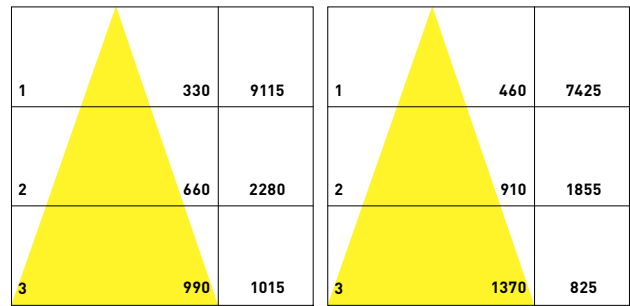

## DIMENSIONES SPOT 20W

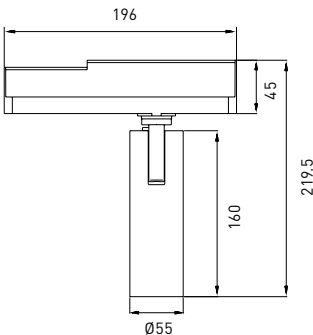

Driver y adaptador incluidos.  
Opción driver DALI disponible.



# CINOR 20W

## RIELES COMPATIBLES

---

Riel 3 efectos marca Artelum modelos: 53411, 53412 y 53413

Riel 3 efectos marca Starnova modelos "Euro"

## ACCESORIOS OPCIONALES

---

Código	Descripción
TL-20W-DPOT	Driver lineal para armado de Cinor en perfil de 20W. Válido para 2 Cinor 11W o 1 Cinor 20W.
TL-30W-DPOT	Driver lineal para armado de Cinor en perfil de 30W. Compatible únicamente con Cinor 27W.

## CONFIGURABLE

---

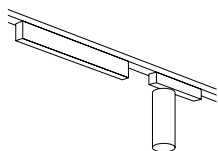

Los artefactos de la línea Cinor son configurables con perfiles Linear, Linear Slim y Slim Box.

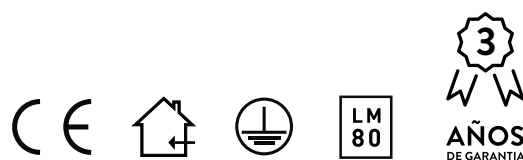



AÑOS  
DE GARANTÍA

LM  
80



## CINOR 27W

Tracklight con driver dimerizable para embutir en riel.  
Cuerpo de aluminio. Antideslumbrante color negro incluido

 2465 lm

 27W 220V

 CRI >90

 PF 0.9

 Dim

 20° / 27° / 36°

 2700K / 3000K / 4000K

 Acabado: negro/blanco

# CINOR 27W

## ESPECIFICACIONES TÉCNICAS

Código	CT	Dim.	Sist. dim	Áng.	CRI	lm	lm/W	W	V	IP
TL65	2700K	Sí	TRIAC	20°/27°/36°	>90	2230	80	27	220	20
TL65	3000K	Sí	TRIAC	20°/27°/36°	>90	2350	85	27	220	20
TL65	4000K	Sí	TRIAC	20°/27°/36°	>90	2465	90	27	220	20

MacAdam <5

## DISTRIBUCIÓN DE INTESIDAD LUMÍNICA

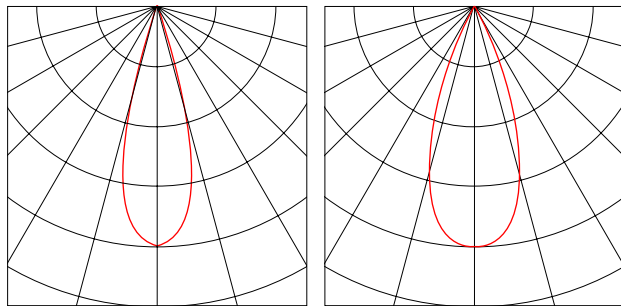

$I_{max}=12375$  cd  
 $\alpha$  C0-C180 =20°

$I_{max}=1090$  cd  
 $\alpha$  C0-C180 =27°

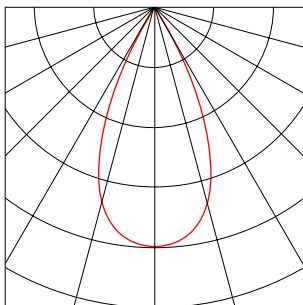

Parámetros  
de fotometría en 3000K

$I_{max}=6076$  cd  
 $\alpha$  C0-C180 =36°

## PROYECCIÓN DE LUZ A DISTANCIA

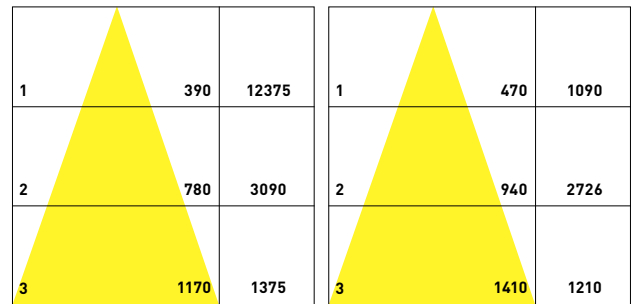

M (Altura) 20° mm (Diámetro) lx

M (Altura) 27° mm (Diámetro) lx

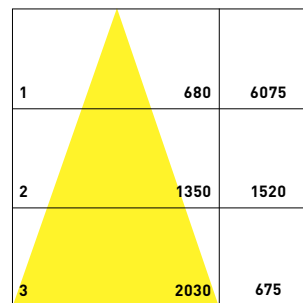

M (Altura) 36° mm (Diámetro) lx

## DIMENSIONES SPOT 27W

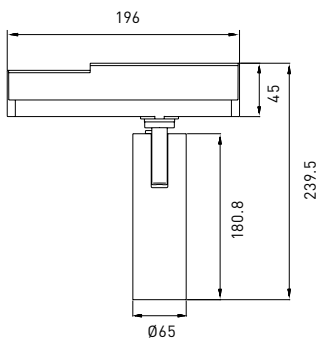

Driver y adaptador incluidos.  
Opción driver DALI disponible.





# CINOR 27W

## RIELES COMPATIBLES

---

Riel 3 efectos marca Artelum modelos: 53411, 53412 y 53413

Riel 3 efectos marca Starnova modelos "Euro"

---

## ACCESORIOS OPCIONALES

---

Código	Descripción
TL-20W-DPOT	Driver lineal para armado de Cinor en perfil de 20W. Válido para 2 Cinor 11W o 1 Cinor 20W.
TL-30W-DPOT	Driver lineal para armado de Cinor en perfil de 30W. Compatible únicamente con Cinor 27W.

## CONFIGURABLE

---

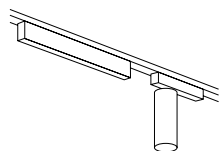

Los artefactos de la línea Cinor son configurables con perfiles Linear, Linear Slim y Slim Box.

